

STEWART LUMBER COMPANY

QUALITY & SERVICE MOULDINGS & MILLWORK FINISH LUMBER

*Dedicated to the prosperity and survival of the Independent Lumber Yard
Our words and our actions are the same*

APRIL 3, 2017

Table of Contents

specie	page	specie	page
Alder (knotty) Lumber	2	Mahogany Moulding	14
Alder (knotty) Moulding	14	Maple Lumber	2
Cedar Paneling	4	Maple Moulding	14
Cedar Lattice	16	Oak Lumber	2
Cedar Shims	16	Oak Moulding	15
Cedar Post Caps	17	Pine Lumber	1
Fir Lumber	1	Pine Paneling / Flooring	3-4
Fir Flooring / Paneling	3	Pine Stepping	5
Fir Stepping & Sills	5	Pine Cant Strip	12
Fir Jambs & Jamb Stock	5	Plinths-Rosettes-Corners	7
Fir Astragal & Mull Post	5	Poplar Lumber	2
Fir Moulding	7-8	Primed F/Joint Lumber	2
Hemlock Lumber	1	Primed F/Joint Moulding	13
Hemlock Paneling	3	Primed U/Lite & Lite Lbr.	2
Hemlock Moulding	9-12	Primed U/Lite Moulding	13
Mahogany Lumber	2	Primed U/Lite Paneling	3

Effective April 3, 2017

QUALITY FINISH LUMBER S4S

code size suggested retail lin.

DOUGLAS FIR - C & Btr. VG (R/L)

FL-5444	1/2 x 2	.63
*FL-0718	1/2 x 3	1.16
*FL-05841	1/2 x 4 (also see F-732)	2.12
*FL-02302	1/2 x 5	2.90
*FL-01523	1/2 x 6	4.63
*FL-07514	1/2 x 8	5.92
*FL-0674	1 x 2	.68
*FL-0268	1 x 3 (also see F-452)	1.23
*FL-08651	1 x 4 (also see F-412)	2.23
FL-00012	1 x 5	2.99
*FL-00533	1 x 6	4.77
*FL-05484	1 x 8	6.90
*FL-01576	1 x 10	9.62
*FL-06719	1 x 12	13.08
*FL-0009	5/4 x 3	1.28
*FL-03681	5/4 x 4	2.65
FL-04532	5/4 x 5	3.35
FL-05093	5/4 x 6	5.56
*FL-00546	5/4 x 8	9.19
FL-02467	5/4 x 10	10.89
*FL-059311	5/4 x 12	16.24
FL-5367	2 x 2	1.09
*FL-03161	2 x 3	2.30
FL-50712	2 x 4	3.09
*FL-07795	2 x 6	8.52
FL-09778	2 x 8	12.51
FL-073221	2 x 10	17.44
FL-032351	2 x 12	21.84

DOUGLAS FIR - C & Btr. MG (R/L)

FL-0879	1 x 4	1.39
FL-59391	1 x 6	2.76
FL-50092	1 x 8	4.13
*FL-05461	2 x 4	2.34
*FL-08772	2 x 6	3.96
*FL-01704	2 x 8	5.80
FL-03025	2 x 10	7.41
FL-59817	2 x 12	10.25
FL-07392	3 x 3	4.19
*FL-01064	3 x 4	6.56
*FL-07218	3 x 6	11.58
FL-082001	3 x 8	14.29
FL-063051	3 x 10	21.43
*FL-035202	3 x 12	28.86

code size suggested retail lin.

DOUGLAS FIR - C & Btr. MG (R/L)

FL-05725	4 x 4	7.52
*FL-026111	4 x 6	15.91
FL-031441	4 x 8	20.54
FL-961002	4 x 10	28.52
FL-001962	4 x 12	38.35
FL-003552	6 x 6	36.38

DOUGLAS FIR ROUGH- C & Btr. VG (R/L)

*FR-00503	8/4 x 4	4.35
*FR-08076	8/4 x 6	9.56
*FR-007101	8/4 x 8	14.49

HEMLOCK - C & Btr. Vertical Grain (R/L)

*HL-0068	1/2 x 4 (also see H-732)	1.23
*HL-04751	1/2 x 6	2.24
*HL-0084	1 x 2	.68
*HL-0996	1 x 3 (also see H-452)	1.00
*HL-0579	1 x 4 (also see H-412)	1.39
*HL-08441	1 x 5	2.06
*HL-05781	1 x 6	2.66
*HL-04692	1 x 8	4.22
*HL-05154	1 x 10	6.43
*HL-00206	1 x 12	8.58
*HL-07831	5/4 x 4	1.98
HL-01852	5/4 x 6	3.68
HL-07193	5/4 x 8	5.58
HL-0068	2 x 2	1.23
*HL-08502	2 x 4	2.93
*HL-04873	2 x 6	5.39
*HL-06706	2 x 8	8.66

HEMLOCK - C & Btr. Mixed Grain (R/L)

*HL-0746	1 x 3	.92
*HL-0219	1 x 4	1.30
*HL-04431	1 x 5	1.92
*HL-09871	1 x 6	2.55
*HL-03252	1 x 8	3.60

PINE LUMBER (6'-16') (Pine prices subject to change.)

Idaho White - Knotty

*PL-0345	1 x 4 Sterling Grade	.77
PL-0377	1 x 6 Sterling Grade	1.10
*PL-0946	1 x 8 Appearance Grade	.92
*PL-0218	1 x 10 Appearance Grade	1.16
*PL-05621	1 x 12 Appearance Grade	1.80

Ponderosa C & Btr.

*PL-08611	1 x 4	1.66
*PL-09291	1 x 6	2.75
PL-03422	1 x 8	3.20

Golf is 20% mechanics & technique. The other 80% is philosophy, humor, tragedy, romance, melodrama, companionship, camaraderie, cussedness, and conversation. by Rice

Effective April 3, 2017

QUALITY FINISH LUMBER S4S

code size suggested retail lin.

ULTRALITE (MDF) - PRIMED 18mm

Gesso Coated - Density 31 lbs per cubic feet

PR-0514	1/2 x 4	16'	.59
PR-0336	1/2 x 6	16'	.90
PR-0482	1 x 2	16'	.40
PR-0724	1 x 3	16'	.61
PR-0965	1 x 4	8' 12' 16'	.81
PR-0177	1 x 5	8' 12' 16'	1.10
PR-0519	1 x 6	8' 12' 16'	1.30
PR-00801	1 x 7	16'	1.54
PR-01021	1 x 8	8' 12' 16'	1.71
PR-00251	1 x 10	16'	2.17
PR-06581	1 x 12	16'	2.64
PR-0848	5/4 x 4	16'	1.21
PR-05921	5/4 x 6	16'	1.85
PR-01071	5/4 x 8	16'	2.42

LITE BOARD(MDF) PRIMED (16') 17mm

Acrylic Latex Primer - Density 40 lbs per cubic feet

PR-0824	1 x 4		.61
PR-0135	1 x 5		.76
PR-0066	1 x 6		.94
PR-0238	1 x 8		1.19
PR-09401	1 x 10		1.49
PR-00921	1 x 12		1.84

MAHOGANY CLEAR - (6'-16') (Meranti)

ML-00771	1/2 x 4		2.52
ML-00523	1/2 x 6		4.63
ML-0347	1 x 2		1.06
ML-07901	1 x 3		1.56
ML-04041	1 x 4		2.00
ML-05191	1 x 5		2.73
ML-07542	1 x 6		3.50
ML-00463	1 x 8		5.19
ML-06264	1 x 10		6.59
ML-09726	1 x 12		8.95

POPLAR PAINT GRADE - (6'-16')

*PL-0088	1 x 2		1.25
*PL-02931	1 x 3		1.98
*PL-06581	1 x 4		2.64
*PL-04642	1 x 5		3.51
*PL-06182	1 x 6		4.01
*PL-06393	1 x 8		5.61
*PL-04452	5/4 x 4		3.63
*PL-00004	5/4 x 6		5.70
*PL-08655	5/4 x 8		7.93

code size suggested retail lin.

FINGER-JOINT PRIMED 16' -Gesso Coated

PF-0546	1/2 x 4		.92
PF-06001	1/2 x 6		1.43
PF-0063	1 x 2		.51
PF-0565	1 x 3		.81
PF-0107	1 x 4		1.00
PF-0309	1 x 5		1.29
PF-02901	1 x 6		1.56
PF-09741	1 x 8		2.11
PF-04491	1 x 10		2.77
PF-02232	1 x 12		3.31
PF-00111	5/4 x 4		1.58
PF-01571	5/4 x 6		2.50
PF-04432	5/4 x 8		3.34

RED OAK - CLEAR (6' 8' 10' 12' 16')(plus 10% for 16')

OL-06762	1/2 x 4		3.81
OL-02914	1/2 x 6		5.97
OL-08701	1 x 2		1.54
OL-01071	1 x 3		2.42
OL-07622	1 x 4		3.23
OL-05143	1 x 5		4.87
OL-08053	1 x 6		5.00
OL-09664	1 x 8		6.65
OL-06736	1 x 10		9.09
OL-00728	1 x 12		11.78
OL-00752	2 x 2 (1-5/16 x 1-5/16)		3.66
OL-03046	2 x 4 (1-5/16 x 3-1/2)		9.12
OL-08429	2 x 6 (1-5/16 x 5-1/2)		13.18
OL-051811	2 x 8 (1-5/16 x 7-1/4)		16.84

HARD MAPLE - (6' 8' 10' 12' 16') (plus 10% for 16')

(Eastern Maple Selected for White)

MA-03151	1 x 2		2.16
MA-05642	1 x 3		3.51
MA-07823	1 x 4		4.68
MA-07044	1 x 5		6.28
MA-06335	1 x 6		7.60
*MA-53856	1 x 8		9.38
MA-004121	1 x 12 (option for E.G.)		17.30

SELECT KNOTTY ALDER (6'-16')

(1 face sanded E.E. & 1 face S.E.)

*AL-0493	1 x 2		.56
*AL-0195	1 x 3		.84
*AL-0498	1 x 4 (also see A-412)		1.27
AL-00811	1 x 5		1.68
AL-02251	1 x 6		2.17
AL-00322	1 x 8		3.18
AL-00411	5/4 x 4		1.62
AL-05691	5/4 x 6		2.80

Effective April 3, 2017

TONGUE & GROOVE MILLWORK

<i>code</i>	<i>size</i>	<i>description</i>	<i>overall width</i>	<i>face</i>	<i>suggested retail lin.</i>
-------------	-------------	--------------------	----------------------	-------------	------------------------------

DOUGLAS FIR FLOORING (6'-20') – Graded For High Quality Appearance



*FL-08651	1x4	C & Btr. VG.....	3/4 x 3-3/8	3-1/8"	2.23
FL-0879	1x4	C & Btr. MG.....	3/4 x 3-3/8	3-1/8"	1.39

DOUGLAS FIR PANELING/FLOORING (R/L)



*FL-07211	5/8x6	Select Tight Knot (6'-16') ..	9/16 x 5-1/4	4-15/16"	1.61
*FL-00533	1x6	C&Btr.VG (6'-20').....	11/16x5-3/8	5-1/8"	4.77

SOUTHERN PINE FLOORING (6'-16')



*PL-08331	1x6	Select Knotty	3/4 x 5-3/8	5-1/8"	1.91
*PL-00281	1x8	Select Knotty	3/4 x 7-1/8	6-7/8"	2.59

DOUGLAS FIR #106 DROP SIDING (6'-20')



*FL-04432	1x6	C & Btr. MG.....	11/16 x 5-5/16	5-1/8"	3.34
-----------	-----	------------------	----------------------	--------------	------

PONDEROSA PINE WP 4 & 6 PANELING (6'-16') (pine prices subject to change)



*PL-0337	1x6	#2 & Btr.....	11/16 x 5-1/4	5"	1.04
*PL-0779	1x8	#2 & Btr.....	11/16 x 7-1/8	6-3/4"	1.39

HEMLOCK BEADED CEILING / #132 VJ PANELING (6'-20')



HL-0138	5/8x4	C & Btr. MG.....	9/16 x 3-5/16	3-1/8"	1.18
*HL-07251	5/8x6	C & Btr. VG.....	9/16 x 5-3/16	5"	2.18

DOUGLAS FIR BEADED CEILING / #132 VJ PANELING (6'-20')



FL-50531	5/8x6	C & Btr. MG.....	9/16 x 5-3/16	5"	1.92
----------	-------	------------------	---------------------	----------	------

DOUGLAS FIR BEADED CEILING (6'-20')



FL-5767	5/8x4	C & Btr. MG.....	9/16 x 3-5/16	3-1/8"	1.09
---------	-------	------------------	---------------------	--------------	------

ULTRALITE (MDF) BEADED CEILING (16')



PR-0574	5/8x4	Primed	9/16 x 3-5/16	3-1/8"68
---------	-------	--------------	---------------------	--------------	-----

(graded face of profiles are face up)

(For special orders - call for quotes)

Coverage Estimator

The following estimator provides factors for determining the exact amount of material needed for basic types of wood siding.

Multiply square footage to be covered by factor (length x width x factor). Coverage estimate to yield board foot quantity needed. Allowance for trim and waste should be added. (10% minimum)

	Nominal Size	WIDTH		AREA FACTOR
		DRESS	FACE	
SHIPLAP	1 x 6	5 1/2	5 1/8	1.17
	1 x 8	7 1/4	6 7/8	1.16
	1 x 10	9 1/4	8 7/8	1.13
	1 x 12	11 1/4	10 7/8	1.10
TONGUE AND GROOVE	1 x 4	3 3/8	3 1/8	1.28
	1 x 6	5 3/8	5 1/8	1.17
	1 x 8	7 1/8	6 7/8	1.16
	1 x 10	9 1/8	8 7/8	1.13
	1 x 12	11 1/8	10 7/8	1.10

	Nominal Size	WIDTH		AREA FACTOR
		DRESS	FACE	
S4S	1 x 4	3 1/2	3 1/2	1.14
	1 x 6	5 1/2	5 1/2	1.09
	1 x 8	7 1/4	7 1/4	1.10
	1 x 10	9 1/4	9 1/4	1.08
	1 x 12	11 1/4	11 1/4	1.07
	PANELING PATTERNS	1 x 6	5 7/16	5 7/16
1 x 8		7 1/8	6 3/4	1.19
1 x 10		9 1/8	8 3/4	1.14
1 x 12		11 1/8	10 3/4	1.12

QUALITY MILLWORK ITEMS

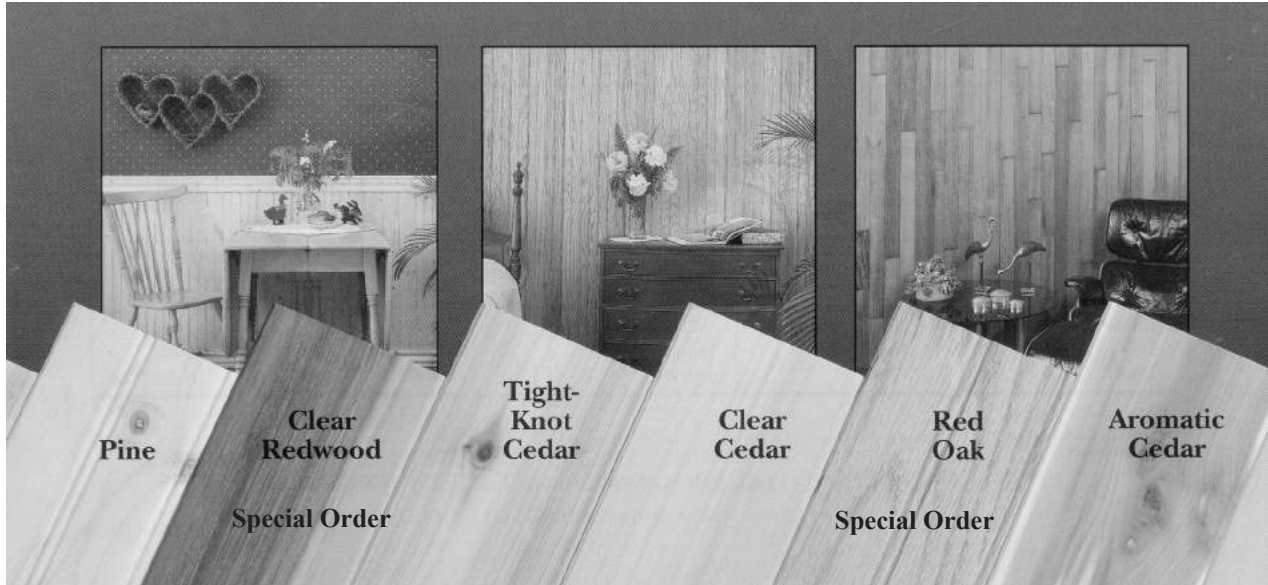

WOODWAY PACKAGED T & G PANELING 5/16 x 3-1/2"

<i>code</i>	<i>order #</i>	<i>name</i>	<i>face</i>	<i>grade</i>	<i>length</i>	<i>suggested retail</i>
					CEDAR (weight 9 1/2 lbs per pkg.) covers 14 S.F. per pkg	
*PA-1506	830.1925	Forest Glen	V-Smooth	Clear	8' only	81.69
*PA-6425	830.1930	Rogue River	V-Smooth	T.K.	8' only	70.82
					PINE (weight 12 1/2 lbs per pkg.) covers 14 S.F. per pkg	
PA-0521	830.1981	Pine Cottage Lake	Dbl. Beaded	Rustic	8' only	16.88
PA-7403	830.1980	Captains Cabin	Dbl. Beaded	T.K.	8' only	41.13
*PA-8772	830.1970	White Springs	V-Smooth	T.K.	8' only	37.50
					AROMATIC CEDAR (weight 11 lbs. per pkg.) covers 12 S.F. per pkg	
*PA-2173	830.2015	Ozark Ridge	V-Smooth	T.K.-E.M.	4' nested	50.11
*PA-0632	830.2016	Ozark Cottage Lake	V-smooth	T.K.-E.M.	4' nested	35.40
(48 Lin. per 8' Pkg.) (36 Pkg. per Pallet - Full Pallets Deduct 11%) (T.K. = Tight Knot) (E.M. = End Matched)						

IF YOU STOCK PANELING YOU WILL SELL IT - DEDUCT 5% FOR STOCKING DEALERS

SPECIAL ORDERS - NON STOCK ITEMS

S4S - Mouldings - Paneling - Flooring - Jambs - Millwork

We will find the best quality for the best price!

HARDWOODS FROM FERCHE - Grade is 100% Useable

- | | |
|---|---|
| 1. Red & White Oak | 6. Knotty Alder & Clear Alder |
| 2. Cherry | 7. Black Walnut |
| 3. White Hard Maple & Soft Maple | 8. Mahogany (seven different species) |
| 4. Poplar (paint, stain, or picked for white) | 9. Hickory plus many more species (sold 83 species last year) |
| 5. Natural Yellow Birch, White Birch | 10. Veneers on any substrate |

Questions to ask for special orders:

- 1.) What is the material used for?
- 2.) Footage - Lengths - Can we sub?
- 3.) Net size - Grade - Grain - Species -Pattern?

SOFTWOODS:

1. Fir(VG - FG) Tight Knot
2. Hemlock (VG - MG)
3. Idaho White Pine & Ponderosa
4. Cedar, Spruce, etc.

QUALITY MILLWORK ITEMS

DOUGLAS FIR STEPPING - (R/L)

suggested retail



<i>code</i>	<i>size</i>	<i>description</i>	<i>lin.</i>
*FL-059311	5/4 x 12 (net 1 x 11-1/4")	C & Btr. VG.....	16.24

PONDEROSA PINE STEPPING / SHELVING (6' - 16')



<i>code</i>	<i>size</i>	<i>description</i>	<i>lin.</i>
*PL-01612	5/4 x 12 (net 1-3/16 x 11-1/4)	#2 & Btr.	3.08

DOUGLAS FIR SILLS - (R/L)



<i>code</i>	<i>size</i>	<i>description</i>	<i>lin.</i>
-------------	-------------	--------------------	-------------



*FL-07505	2 x 8 (net 1-1/2 x 7-1/16)	Bevel Sill MG.....	7.20
-----------	----------------------------	--------------------	------



*FL-07505	2 x 8 (net 1-1/2 x 7-1/16)	Step Sill MG.....	7.20
-----------	----------------------------	-------------------	------

*FL07505	2 x 8 (net 1-3/8 x 7-1/16)	Rabbeted Door Sill MG.....	7.20
----------	----------------------------	----------------------------	------

*FL-02507	2 x 10 (net 1-3/8 x 8-15/16)	Rabbeted Door Sill MG.....	10.05
-----------	------------------------------	----------------------------	-------

DOUGLAS FIR JAMB STOCK - (R/L)



<i>code</i>	<i>size</i>	<i>description</i>	<i>lin.</i>
-------------	-------------	--------------------	-------------

*FL-07153	5-1/4 x 1-13/16	SR Jamb MG	5.01
-----------	-----------------	------------------	------

*FL-07505	7 x 1-13/16	SR Jamb MG	7.20
-----------	-------------	------------------	------

*FL-02507	9 x 1-13/16	SR Jamb MG	10.05
-----------	-------------	------------------	-------

DOOR JAMBS & FIR ASTRAGALS



<i>code</i>	<i>size</i>	<i>length</i>	<i>pair</i>
-------------	-------------	---------------	-------------

*JS-4395	4-9/16 x 1-3/8 DR VG Fir Veneer Wrap	81-5/8" Pairs	84.56
----------	--------------------------------------	---------------------	-------



*JS-0477	4-9/16 x 2-1/8 SR VG Fir Veneer Wrap (kerfed)	87" Pairs	110.30
----------	---	-----------------	--------

*JS-33701	6-9/16x2-1/8 SR VG Fir Veneer Wrap(kerfed)	87" Pairs	152.94
-----------	--	-----------------	--------



M-0598	2 x 4-9/16 VG Fir Veneer Mull Post	98"	134.25 ea
--------	------------------------------------	-----------	-----------

M-5836	2 x 4-9/16 VG Hemlock E.G. Mull Post	98"	95.78 ea
--------	--------------------------------------	-----------	----------

M-8173	2 x 4-9/16 Primed Finger-joint Mull Post	98"	55.77 ea
--------	--	-----------	----------



*FM-7232	F-1317 Kerfed 3 Fir Astragal	7'.....	34.91 ea
----------	------------------------------	---------	----------

*FM-5862	F-1317 Kerfed 3 Fir Astragal	8'.....	40.28 ea
----------	------------------------------	---------	----------



FM-5391	F-1311 1-3/4 T-Offset Fir Astragal	8'.....	29.00 ea
---------	------------------------------------	---------	----------

Effective April 3, 2017

BUILD-UPS CROWNS

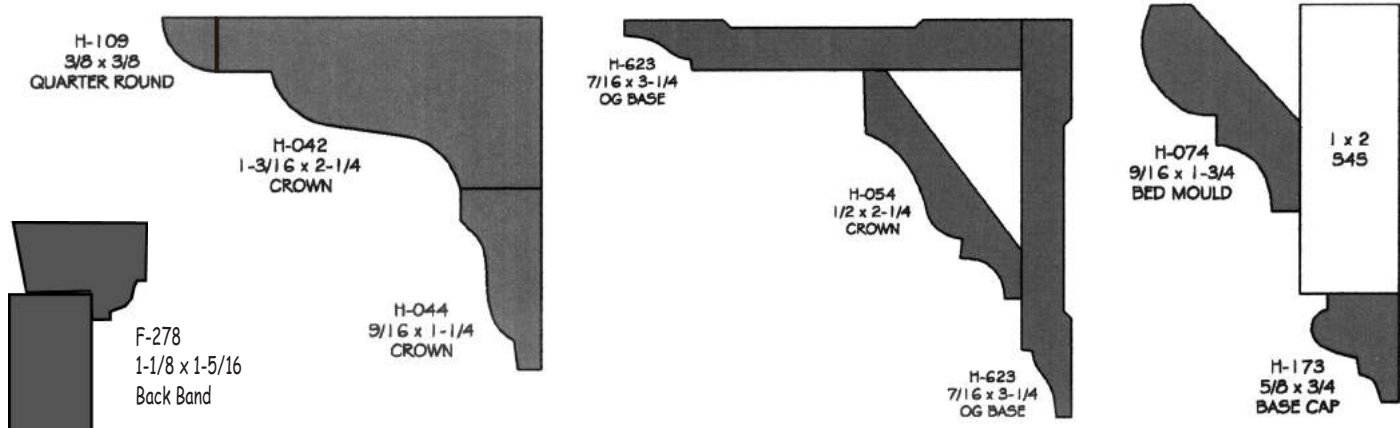

CHAIR RAILS

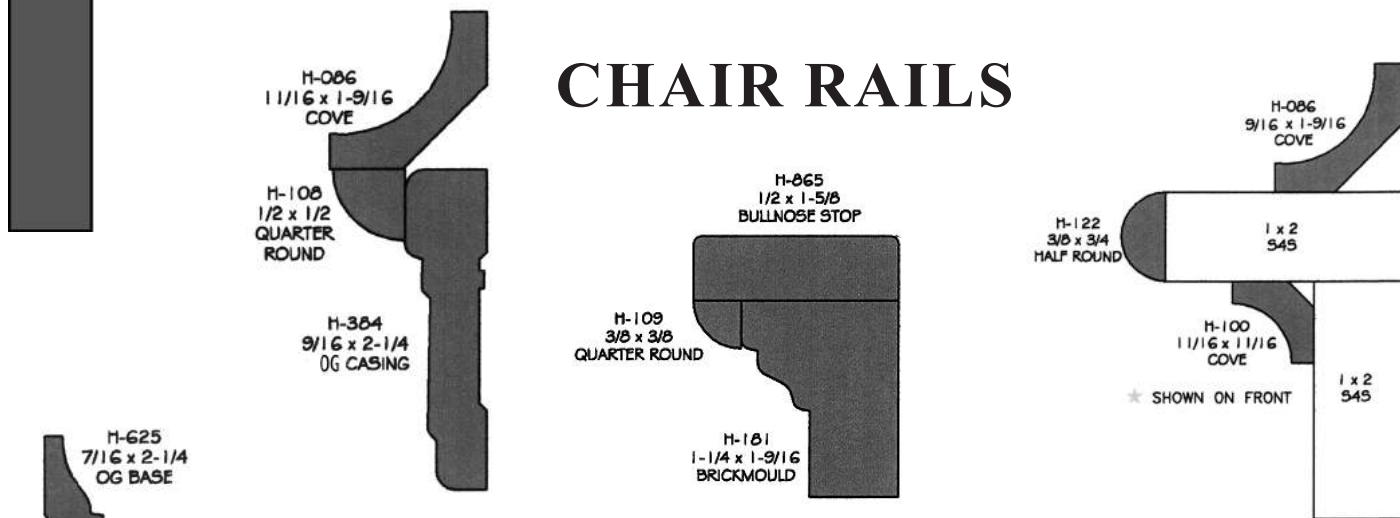

BASES

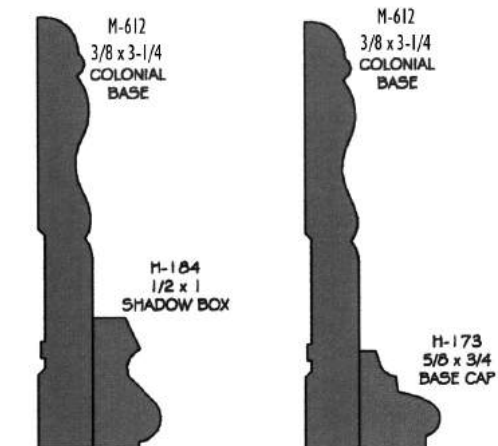

CASINGS

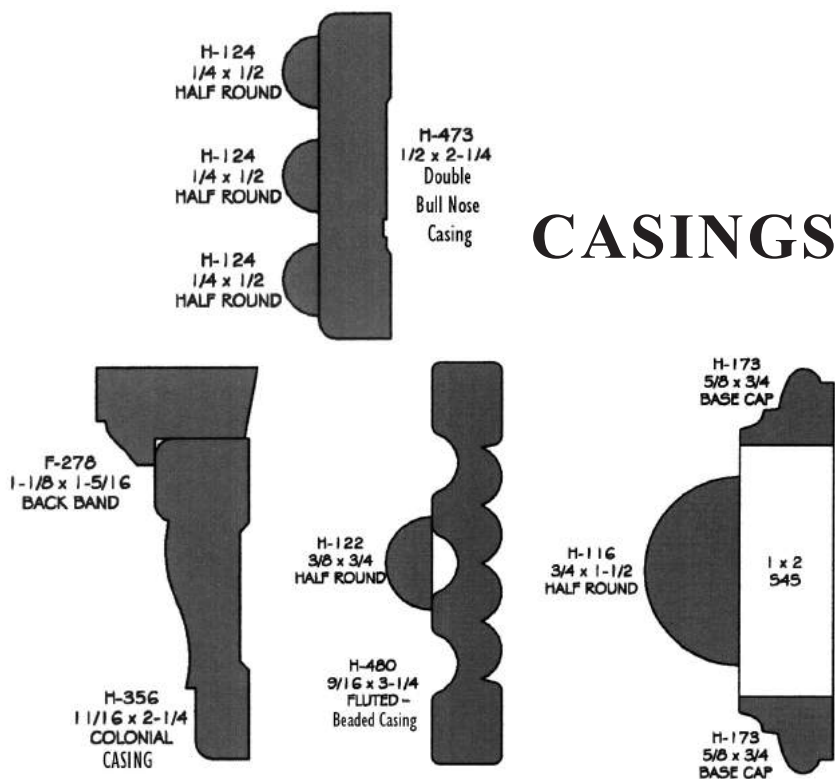

Effective April 3, 2017

QUALITY MILLWORK ITEMS

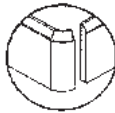

SOFTLINE WOOD CORNERS

<i>code</i>	<i>order #</i>	<i>matches profile</i>	<i>ctn.</i>	<i>suggested retail</i>
SC-361	SCH-340	Moulded Csg. 9/16 x 2-1/4 HEM.....	50	2.81 ea
SC-361	SCH-356	Colonial Csg. 11/16 x 2-1/4 HEM.....	50	2.81 ea
SC-361	SCM-356	Colonial Csg. 5/8 x 2-1/4 MDF.....	50	2.81 ea
SC-361	SCH-393	Beaded Csg. 9/16 x 1-9/16 HEM.....	50	2.81 ea
SC-003	SCH-412	Univ. Dbl. BN 23/32 x 3-1/2 HEM.....	50	5.18 ea
SC-814	SCO-451	Univ. Dbl. BN 3/4 x 2-3/4 OAK.....	25	7.21 ea
SC-361	SCH-473	Double BN Csg. 1/2 x 2-1/4 HEM.....	50	2.81 ea
SC-902	SCM-508	Universal 5/8 x 2-1/2 MDF.....	50	3.61 ea
SC-452	SCM-611	Gingerbread 7/16 x 3-7/8 MDF.....	50	4.38 ea
SC-043	SCM-618	OG Base 1/2 x 5-1/4 MDF.....	50	5.87 ea
SC-043	SCH-618	OG Base 9/16 x 5-1/4 Hem.....	50	5.87 ea
SC-532	SCH-623	OG Base 7/16 x 3-1/4 Hem.....	50	4.05 ea
SC-532	SCM-623	OG Base 1/2 x 3-1/4 MDF.....	50	4.05 ea



RAINBOW WOOD CORNERS

*SC-302	SRH-356	Colonial Csg. 11/16 x 2-1/4 Hem.....	50	3.50 ea
---------	---------	--------------------------------------	----	---------

BULLSEYE ROSETTES

*RO-302	SBR-312	3/4 x 3-1/2 Alder (edge glued).....	100	3.50 ea
RO-881	SBM-312	3/4 x 3-1/2 MDF Primed.....	100	3.24 ea
RO-441	SBM-212	3/4 x 2-1/2 MDF Primed.....	200	2.48 ea

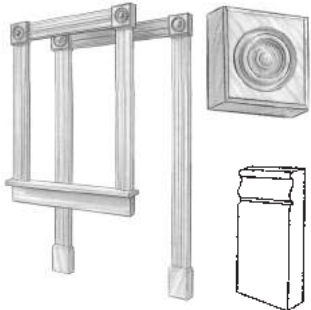

PLINTH BLOCKS

RO-022	SPB-312	3/4 x 3-1/2 x 6-1/2 Alder(edgeglued).....	50	3.80 ea
RO-002	SPM-312	3/4 x 3-1/2 x 6-1/2 MDF Primed.....	50	3.45 ea

(Priced per each - deduct 10% for full cartons)





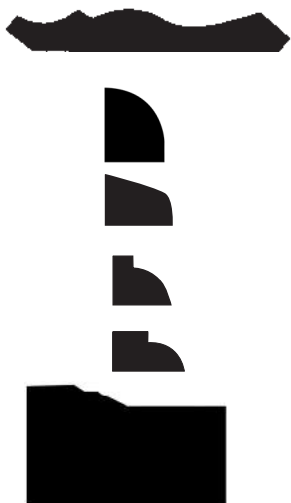









DOUGLAS FIR MOULDINGS

<i>code</i>	<i>order #</i>	<i>description</i>	<i>lengths</i>	<i>bdl.</i>	<i>suggested retail</i>
FM-01071	F-051	9/16 x 3-1/4 Crown (VG)	R/L	(4)	2.93
FM-0853	F-126	1/2 x 3/4 Base Shoe (MG)	6-12'	(20)	.62
FM-0052	F-151	7/16 x 9/16 Bevel Bead (MG)	6-12'	(20)	.43
FM-0052	F-155	3/8 x 7/16 Glass Bead (MG)	6-12'	(20)	.43
FM-0052	F-159	3/8 x 11/16 Glass Bead (MG)	6-12'	(20)	.43
FM-08731	F-180	1-1/4 x 2 Brick Mould (MG)	7'	(4)	2.38
FM-03521	F-180	1-1/4 x 2 Brick Mould (MG)	R/L	(4)	2.16



Effective April 3, 2017

















DOUGLAS FIR MOULDINGS-CONTINUED

	<i>code</i>	<i>order #</i>	<i>description</i>	<i>lengths</i>	<i>suggested bdl.</i>	<i>retail lin.</i>
	*FM-0598	F-181	1-1/4 x 1-9/16 Brick Mould (MG)	R/L	(8)	1.54
	FM-0569	F-188	1-1/16 x 1-5/8 Drip Cap (MG)	R/L	(8)	1.66
	*FM-07142	F-190	1-5/16 x 2-3/8 Drip Cap (MG)	R/L	(4)	4.17
	*FM-06052	F-200	1-5/16 x 3 Corner Post (MG) (2 x 4)	R/L	(PC)	4.32
	*FM-04701	F-265	1/4 x 2-1/4 Batten (VG)	8', 10', 12'	(20)	1.85
	*FM-0778	F-278	1-1/8 x 1-5/16 Back Band (MG)	R/L	(6)	1.51
	FM-0598	F-279	1-1/8 x 1-3/8 Cap Mould (MG)	R/L	(6)	1.54
	FM-02251	F-283	1-3/8 x 2-7/16 Cap Mould (MG)	R/L	(4)	2.63
	FM-05701	F-356	11/16 x 2-1/4 Colonial Csg (VG)	R/L	(8)	1.85
	*FM-01071	F-412	11/16 x 3-1/2 DBN Casing (VG)	7'	(6)	2.42
	FM-05751	F-412	11/16 x 3-1/2 DBN Casing (VG)	R/L	(6)	2.24
	FM-00421	F-452	11/16 x 2-1/2 DBN Casing (VG)	7'	(6)	1.77
	FM-00811	F-452	11/16 x 2-1/2 DBN Casing (VG)	R/L	(6)	1.68
	*FM-01071	F-623	5/8 x 3-1/4 OG Base (VG)	R/L	(4)	2.93
	*FM-02251	F-732	1/2 x 3-1/2 BN Base (VG)	R/L	(6)	2.17
	FM-00052	F-909	1-1/16 x 3-1/4 Stair Nosing (VG)	R/L	(6)	4.31
	FM-0004	F-952	7/16 x 1-1/4 Fillet (MG)	R/L	(20)	.69
	FM-05314	F-1021	1 x 5-3/8 French Stool (VG) (net 1" thick)	R/L	(8)	7.13

Random Length Mouldings are 6' to 16' (or longer)











Effective April 3, 2017

HEMLOCK MOULDINGS

	<i>code</i>	<i>order #</i>	<i>description</i>	<i>lengths</i>	<i>bdl.</i>	<i>suggested retail lin.</i>
	*HM-00451	H-042	1-3/16 x 2-1/4 Crown	8', 10', 12'	(8)	2.66
	*HM-0015	H-044	9/16 x 1-1/4 Crown	8', 10', 12'	(12)	.88
	*HM-0033	H-046	1/2 x 11/16 Crown	8', 10', 12'	(20)	.57
	*HM-00421	H-049	1/2 x 3-9/16 Crown	8',10',12',14',16'	(8)	2.14
	*HM-0908	H-054	1/2 x 2-1/4 Crown	8',10',12',14',16'	(8)	1.40
	*HM-0285	H-068	7/16 x 1-5/8 Crown	8', 12'	(12)	1.00
	*HM-0766	H-074	9/16 x 1-3/4 Bed Mould	8',10',12',14',16'	(10)	1.15
	*HM-0908	H-084	9/16 x 2-1/4 Cove	8', 10', 12'	(8)	1.40
	*HM-0395	H-086	9/16 x 1-9/16 Cove	8', 10', 12'	(10)	1.02
	*HM-0114	H-100	11/16 x 11/16 Cove	8', 10', 12'	(20)	.71
	*HM-0252	H-101	1/2 x 1/2 Cove	8', 10', 12'	(20)	.43
	*HM-0224	H-105	3/4 x 3/4 Quarter Rd	8', 10', 12'	(20)	.73
	*HM-0062	H-108	1/2 x 1/2 Quarter Rd	8', 10', 12'	(20)	.45
	*HM-0432	H-109	3/8 x 3/8 Quarter Rd	8', 10', 12'	(20)	.40
	*HM-0781	H-110	1/4 x 1/4 Quarter Rd	8', 10', 12'	(20)	.32
	*HM-0977	H-116	3/4 x 1-1/2 Half Round	8', 10', 12'	(12)	1.34
	*HM-0834	H-120	1/2 x 1 Half Round	8', 10', 12'	(20)	.76
	*HM-0313	H-122	3/8 x 3/4 Half Round	8', 10', 12'	(20)	.54
	*HM-0422	H-124	1/4 x 1/2 Half Round	8', 10', 12'	(20)	.39
	*HM-0523	H-126	1/2 x 3/4 Base Shoe	8', 10', 12'	(20)	.56
	*HM-0272	H-142	1/4 x 3/4 BN Screen Mould	8', 10', 12'	(20)	.47
	*HM-0324	H-173	5/8 x 3/4 Base Cap	8',10',12',14',16'	(20)	.73
	*HM-04931	H-180	1-1/4 x 2 Brick Mould	7',8',10',12',18'	(4)	2.40
	*HM-02311	H-181	1-1/4 x 1-9/16 Brick Mould	7',8',10',12',18'	(8)	1.95

Effective April 3, 2017

HEMLOCK MOULDINGS-CONTINUED

	<i>code</i>	<i>order #</i>	<i>description</i>	<i>lengths</i>	<i>suggested bdl.</i>	<i>retail</i>
	*HM-0395	H-182	9/16 x 1-9/16 Panel Mould	8', 10', 12'	(12)	1.02
	*HM-0204	H-184	1/2 x 1 Shadow Box	8', 10', 12'	(20)	.69
	*HM-09511	H-204	1-5/16 x 1-5/16 O.S. Corner	8', 10', 12'	(10)	2.00
	*HM-0908	H-205	1-1/16 x 1-1/16 O.S. Corner	8', 10', 12'	(20)	1.40
	*HM-0383	H-206	3/4 x 3/4 O.S. Corner	8', 10', 12'	(20)	.66
	*HM-00841	H-231	1-5/16 x 1-5/8 Hand Rail	8' & Lgr	(4)	2.55
	*HM-02941	H-232	1-5/8 Full Round	R/L	(4)	2.57
	*HM-0927	H-233	1-5/16 Full Round	R/L	(10)	1.26
	*HM-0908	H-234	1 Full Round	8', 10', 12'	(12)	1.40
	*HM-0285	H-235	3/4 Full Round	8', 10', 12'	(20)	1.00
	*HM-0908	H-238	1-1/16 x 1-1/16 Square	8', 10', 12'	(10)	1.40
	*HM-0824	H-239	11/16 x 11/16 Square	8', 10', 12'	(20)	.74
	*HM-05761	H-240	1-1/4 x 2-1/4 Hand Rail (2 x 3)	8', 10', 12', 14', 16'	(4)	2.89
	*HM-0323	H-254	1/2 x 3/4 Parting Bead	8', 10', 12'	(20)	.56
	*HM-0464	H-264	1/4 x 2-1/8 Lattice	8', 10', 12'	(20)	.80
	*HM-0473	H-266	1/4 x 1-5/8 Lattice	8', 10', 12'	(20)	.65
	*HM-0593	H-267	1/4 x 1-3/8 Lattice	8', 10', 12'	(20)	.68
	*HM-0513	H-269	1/4 x 1-1/16 Lattice	8', 10', 12'	(20)	.54
	*HM-0817	H-273	5/8 x 1-3/4 Picture Mould	8', 10', 12', 14', 16'	(12)	1.24
	*HM-09731	H-283	1-3/8 x 2-7/16 Cap Mould	R/L	(4)	2.38





Effective April 3, 2017

HEMLOCK MOULDINGS-CONTINUED

	<i>code</i>	<i>order #</i>	<i>description</i>	<i>lengths</i>	<i>bdl.</i>	<i>suggested retail</i>
	*HM-0395	H-291	5/8 x 1-3/8 Panel Cap	8', 10', 12'	(12)	1.02
	*HM-0315	H-292	9/16 x 1-1/8 Wainscot Cap	8', 10', 12'	(20)	.88
	*HM-0259	H-293	3/4 x 1-15/16 Panel Cap	8', 10', 12'	(6)	1.64
	*HM-0259	H-296	9/16 x 2-1/2 Chair Rail	8', 10', 12'	(8)	1.64
	*HM-07901	H-297	11/16 x 3 Chair Rail	8', 10', 12'	(6)	1.89
	*HM-0385	H-300	9/16 x 1-1/2 Wedge Csg	7', 8', 10', 12'	(12)	1.01
	*HM-0908	H-324	9/16 x 2-1/4 Wedge Csg	7', 8', 10', 12'	(8)	1.40
	*HM-0195	H-325	9/16 x 1-9/16 S/L Csg	7', 8', 10', 12'	(12)	1.02
	*HM-0908	H-327	9/16 x 2-1/4 S/L Csg	7', 8', 10', 12'	(8)	1.40
	*HM-0908	H-340	9/16 x 2-1/4 Moulded Csg	7', 8', 10', 12'	(8)	1.40
	*HM-07901	H-341	5/8 x 3-1/4 Moulded Csg	8', 10', 12'	(8)	1.89
	*HM-03901	H-344	11/16 x 3-1/4 Colonial Csg	8', 10', 12'	(8)	1.89
	*HM-0167	H-356	11/16 x 2-1/4 Colonial Csg	7', 8', 10', 12', 14', 16'	(8)	1.31
	*HM-0908	H-384	9/16 x 2-1/4 OG Csg	7', 8', 10', 12'	(8)	1.40
	*HM-0116	H-393	9/16 x 1-9/16 Beaded Csg	7', 8', 10', 12'	(12)	1.05
	*HM-0259	H-395	9/16 x 2-1/2 Beaded Csg	7', 8', 10', 12'	(8)	1.64
	*HM-07901	H-396	5/8 x 3-1/4 Beaded Csg	8', 10', 12'	(8)	1.89
	*HM-01821	H-412	11/16 x 3-1/2 DBN Csg (VG)	7', 8', 10', 12'	(6)	1.83
	*HM-03201	HV-412	11/16 x 3-1/2 DBN Csg (VG)	7', 8' (Veneer)	(6)	1.46











Effective April 3, 2017

HEMLOCK MOULDINGS-CONTINUED

	<i>code</i>	<i>order #</i>	<i>description</i>	<i>lengths</i>	<i>suggested bdl.</i>	<i>retail</i>
	*HM-0908	H-442	9/16 x 2-1/4 Beaded Csg	7', 8', 10', 12'	(8)	1.40
	*HM-0589	H-452	11/16 x 2-1/2 DBN Csg (VG)	7', 8', 10', 12'	(6)	1.40
	*HM-0077	HV-452	11/16 x 2-1/2 DBN Csg (VG)	7', 8', (Veneer)	(6)	1.10
	*HM-0685	H-470	1/2 x 1-1/2 DBN Casing	7', 8', 10', 12'	(12)	1.01
	*HM-0908	H-473	1/2 x 2-1/4 DBN Casing	7', 8', 10', 12'	(8)	1.40
	*HM-07901	H-480	9/16 x 3-1/4 Fluted/Beaded Csg	8'	(8)	1.89
	*HM-0259	H-508	11/16 x 2-1/2 Universal Mould	8', 12'	(8)	1.64
	*HM-00011	H-612	3/8 x 3-1/4 Colonial Base	8', 12',	(8)	1.90
	*HM-0695	H-615	9/16 x 1-9/16 Wedge Base	8', 10', 12'	(12)	1.03
	*HM-09691	H-618	9/16 x 5-1/4 OG Base	8', 10', 12', 14', 16'	(6)	3.40
	*HM-0048	H-623	7/16 x 3-1/4 OG Base	8', 10', 12', 14', 16'	(8)	1.45
	*HM-0026	H-625	7/16 x 2-1/4 OG Base	8', 10', 12', 14', 16'	(8)	1.07
	*HM-07901	H-723	7/16 x 3-1/4 S/L Base	8', 10', 12', 14', 16'	(8)	1.89
	*HM-0908	H-726	7/16 x 2-1/4 S/L Base	8', 10', 12', 14', 16'	(8)	1.40
	*HM-02601	H-732	1/2 x 3-1/2 BN Base (VG)	R/L	(6)	1.51
	*HM-03771	H-736	1/2 x 5-1/2 BN Base (VG)	R/L	(4)	2.53
	*HM-0908	H-790	11/16 x 2-1/4 Sanitary Base	8', 10', 12'	(8)	1.40
	*HM-0395	H-796	9/16 x 1-1/2 Sanitary Base	8', 10', 12'	(12)	1.02
	*HM-0874	H-845	7/16 x 1-7/16 S/L Base	8', 10', 12'	(12)	.82
	*HM-0908	H-863	7/16 x 2-1/4 Bullnose Stop	7' 8', 10', 12'	(8)	1.40
	*HM-0486	H-865	7/16 x 1-5/8 Bullnose Stop	8', 10', 12'	(12)	1.18
	*HM-0015	H-866	1/2 x 1-3/8 Bullnose Stop	8', 10', 12'	(20)	.88
	*HM-0204	H-869	1/2 x 1-1/16 Bullnose Stop	7' 8', 10', 12'	(20)	.69
	*HM-0204	H-870	1/2 x 7/8 Bullnose Stop	7' 8', 10', 12'	(20)	.69
	*HM-0015	H-936	7/16 x 1-3/8 OG Stop	7' 8', 10', 12'	(20)	.88
	*HM-0493	H-952	7/16 x 1-1/4 Fillet	8', 10', 12'	(20)	.68
	*HM-0623	H-994	1-1/2 x 1-1/2 Cant Strip (Pine)	8'	250 lin.	.56
	*HM-0121	H-995	3/4 x 3/4 Cant Strip (Pine)	12'	500 lin.	.21

Effective April 3, 2017

PRIMED MOULDINGS - ULTRALITE (MDF) AND FINGER-JOINT PINE*Ultralite – No Volcano – Light Weight – No Chips – No Splits – Smooth Prime Coating*

	<i>code</i>	<i>order #</i>	<i>description</i>	<i>lengths</i>	<i>bdl.</i>	<i>suggested retail</i>
	PM-0028	P-045	9/16 x 5-1/4 Crown	16'	(4)	1.41
	PM-0086	P-048	9/16 x 4-1/4 Crown	16'	(4)	1.17
	PM-0015	P-051	9/16 x 3-1/4 Crown	16'	(4)	.88
	PM-0922	PF-105	3/4 x 3/4 Quarter Round (F/J)	16'	(20)	.40
	PM-0022	PF-126	1/2 x 3/4 Base Shoe (F/J)	16'	(20)	.38
	PM-0657	PF-180	1-1/4 x 2 Brick Mould (F/J)	14'	(8)	1.30
	PM-0032	P-300	1/2 x 1-1/2 Wedge Casing	14'	(12)	.40
	PM-0063	P-340	9/16 x 2-1/4 Moulded Casing	16'	(6)	.62
	PM-0063	P-356	5/8 x 2-1/4 Colonial Casing	7', 10', 16'	(6)	.62
	PM-0084	PF-356	11/16 x 2-1/4 Colonial Csg (F/J)	14'	(8)	.83
	PM-0035	P-444	5/8 x 3-1/4 Colonial Casing	16'	(6)	.91
	*PM-0923	P-473	9/16 x 2-1/4 DBN Casing (LDF-lite)	16'	(6)	.57
	PM-0684	PF-473	9/16 x 2-1/4 DBN Casing (F/J)	16'	(6)	.84
	PM-0025	P-480	9/16 x 3-1/4 Fluted Casing	8'	(4)	.90
	PM-0024	P-508	5/8 x 2-1/2 Universal Mould	16'	(6)	.72
	PM-0045	P-611	7/16 x 3-7/8 Gingerbread Base	16'	(6)	.93
	PM-0096	P-618	1/2 x 5-1/4 OG Base	16'	(4)	1.19
	PM-0054	P-623	1/2 x 3-1/4 OG Base	16'	(6)	.78
	PM-0325	PF-623	7/16 x 3-1/4 OG Base (F/J)	16'	(6)	.90
	PM-0043	P-625	1/2 x 2-1/4 OG Base	16'	(6)	.59
	PM-0014	PF-625	7/16 x 2-1/4 OG Base (F/J)	16'	(6)	.71
	PM-0078	P-635	9/16 x 5-1/4 Colonial Base	16'	(4)	1.50
	PM-0049	P-755	9/16 x 5-5/8 Beaded Base	16'	(4)	1.62
	PM-0603	PF-952	7/16 x 1-1/4 Fillet (F.J.)	12'	(20)	.53

Effective April 3, 2017

MAHOGANY MOULDINGS (Meranti)

<i>code</i>	<i>order #</i>	<i>description</i>	<i>lengths</i>	<i>bdl.</i>	<i>suggested retail</i>
*MM-0735	M-100	11/16 x 11/16 Cove	8', 12'	(20)	.93
*MM-0735	M-105	11/16 x 11/16 Quarter Round	8', 12'	(20)	.93
*MM-0735	M-126	7/16 x 3/4 Base Shoe	8', 10', 12'	(20)	.93
MM-0033	M-142	1/4 x 3/4 BN Screen Mould	8'	(25)	.57
MM-0019	M-205	1 x 1 O.S. Corner	8'	(10)	1.57
MM-0006	M-206	11/16 x 11/16 O.S. Corner	8'	(10)	1.04
*MM-0224	M-300	1/2 x 1-9/16 Combo Csg/Base	7'	(20)	.73
*MM-0383	M-300	1/2 x 1-9/16 Combo Csg/Base	R/L 6-16'	(20)	.66
*MM-0946	M-324	1/2 x 2-1/4 Bevel Casing	7', 8', 10', 12'	(10)	1.12
*MM-0978	M-327	5/8 x 2-1/4 S/L Casing	7', 8', 10', 12'	(10)	1.52
*MM-0529	M-727	3/8 x 2-3/4 S/L Base	8', 10', 12'	(10)	1.60
*MM-04021	M-790	5/8 x 2-1/4 Sanitary Base	8', 10', 12'	(10)	2.08
MM-0056	M-865	3/8 x 1-5/8 Dbl BN Stop	8', 10'	(20)	1.12
MM-0005	M-866	3/8 x 1-1/4 Dbl BN Stop	8', 10'	(20)	.86

HARD MAPLE-SELECT EASTERN WHITE



















<i>code</i>	<i>order #</i>	<i>description</i>	<i>lengths</i>	<i>bdl.</i>	<i>retail</i>
MO-0777	MA-126	7/16 x 3/4 Base Shoe	8', 10', 12'	(10)	1.17
MO-0937	MA-142	5/16 x 3/4 BN Screen Mould	8'	(10)	1.11
MO-01921	MA-896	3/8 x 1-3/4 Counter Edge	8', 10', 12'	(10)	1.94
MO-00504	MA-898	5/8 x 3-1/2 Backsplash	8', 10', 12'	(6)	6.08

SELECT KNOTTY ALDER

<i>code</i>	<i>order #</i>	<i>description</i>	<i>lengths</i>	<i>bdl.</i>	<i>rretail</i>
AM-0598	A-412	11/16 x 3-1/2 DBN Casing	7'	(6)	1.28
AM-0418	A-412	11/16 x 3-1/2 DBN Casing	R/L	(6)	1.16
AM-0176	A-452	11/16 x 2-1/2 DBN Casing	7'	(6)	.96
AM-0016	A-452	11/16 x 2-1/2 DBN Casing	R/L	(6)	.87
AM-01441	A-736	1/2 x 5-1/2 BN Base	R/L	(6)	2.05
AM-0704	A-952	7/16 x 1-1/4 Fillet	R/L	(20)	.58

Effective April 3, 2017

RED OAK MOULDINGS

<i>code</i>	<i>order #</i>	<i>description</i>	<i>lengths</i>	<i>bdl.</i>	<i>suggested retail</i>
	OM-04092 O-051	11/16 x 3-1/4 Crown	8' 10' 12'	(6)	4.36
	OM-0178 O-093	3/4 x 3/4 Cove	8'	(20)	1.31
	OM-0178 O-105	3/4 x 3/4 Quarter Round	8'	(20)	1.31
	OM-0765 O-126	7/16 x 3/4 Base Shoe	8', 10', 12'	(20)	.85
	OM-0125 O-142	5/16 x 3/4 BN Screen Mould	8'	(25)	.78
	OM-02641 O-205	1-1/16 x 1-1/16 O.S. Corner	8', 10'	(10)	2.19
	OM-0658 O-206	3/4 x 3/4 O.S. Corner	8', 10'	(20)	1.28
	OM-0939 O-239	3/4 x 3/4 Square	8'	(20)	1.41
	OM-03181 O-293	11/16 x 2 Panel Cap	8', 10', 12'	(10)	2.72
	OM-0049 O-300	9/16 x 1-1/2 Bevel Csg	7', 8', 10', 12'	(12)	1.41
	OM-0859 O-324	1/2 x 2-1/4 Bevel Csg	7', 8', 10', 12'	(10)	1.44
	OM-0979 O-356	1/2 x 2-1/4 Colonial Csg	7', 8', 10', 12'	(10)	1.47
	OM-04931 O-473	7/16 x 2-1/4 Dbl BN Csg	7', 8', 10', 12'	(10)	2.09
	OM-07611 O-626	3/8 x 2-3/4 OG Base	8', 10', 12'	(10)	1.75
	OM-07611 O-724	3/8 x 2-3/4 S/L Base	8', 10', 12'	(10)	1.75
	*OM-0186 O-895	3/8 x 1-1/4 Counter Edge	8', 10', 12'	(20)	1.02
	OM-0578 O-896	3/8 x 1-3/4 Counter Edge	8', 10', 12'	(10)	1.31
	OM-07292 O-898	5/8 x 3-1/2 Counter Backsplash	8', 10', 12'	(6)	4.39
	*OM-0817 O-936	7/16 x 1-3/8 OG Stop	8'	(20)	1.08

Effective April 3, 2017

QUALITY CEDAR LATTICE

Lattice Works of Oregon stands behind their quality of lath. Lath is graded based on Western Wood Prod. Association lath grading rules. Stapled at each intersection and glued giving a lattice face free of staples.

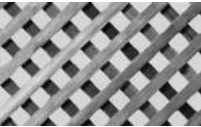
<i>piece</i>	<i>unit 15</i>	<i>unit 30</i>	<i>description</i>	<i>order #</i>	<i>suggested retail each</i>
					
DIAGONAL PRIVACY			1-7/8" OPENING (70% SHADE)	Non-rust Stainless Steel Staples	
*LA-0616	LA-2585	LA-9374	3/8" x 4 x 8 Clear Face.....	810.1087.....	80.08
*LA-3761		LA-7821(60pc)	3/8" x 1 x 8 #1	810.1060A.....	21.75
*LA-7688	LA-4248	LA-1286	13/16" x 4 x 8 #1 H.D.	810.1140A.....	115.27

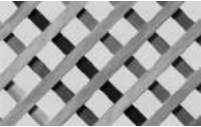
					
DIAGONAL GARDEN			2-5/8" OPENING (50% SHADE)	Galvanized Staples	
*LA-5962		LA-3702(60 pc)	3/8" x 4 x 8 Select	810.1080.....	35.04
*LA-6804	LA-2883	LA-2413	13/16" x 4 x 8 Select H.D. ..	810.1135.....	53.12
	Full units when available	LA-2382	13/16" x 4 x 8 Promo H.D. .	810.1136.....	36.82

					
SQUARE PRIVACY			1-3/4" OPENING (70% SHADE)	Non-rust Stainless Steel Staples	
*LA-1507	LA-9966	LA-4245	3/8" x 4 x 8 #1	810.1114A.....	91.66
*LA-03601	LA-99001	LA-7718	13/16" x 4 x 8 #1 H.D.	810.1154A.....	138.19

					
MODERNA PANEL SCREEN			3/4" OPENING	Non-rust Stainless Steel Staples	
*LA-86941	LA-02241	LA-41511	13/16" x 4 x 8 Clear	810.1209.....	194.58

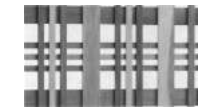
					
ESTATE LATTICE - SQUARE PATTERN (Wide & Narrow Lath)			Non-rust Stainless Steel Staples		
*LA-5086	LA-8365	Catalina	13/16" x 3 x 6 #1 Premium	810.3098.....	88.47

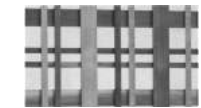
					
*LA-6885	LA-6784	Monterey	13/16" x 3 x 6 #1 Premium	810.3097.....	76.52

CLEAR CEDAR MOULDINGS-8' LENGTHS ONLY			<i>retail</i>		
<i>code</i>	<i>description</i>		<i>order #</i>	<i>bdl</i>	<i>each</i>
					
*CM-639	1/2" groove	1 x 2 Standard Cap	815.1625	(18).....	14.04
*CM-0171	1/2" groove	2 x 2 Standard Divider.....	815.1630	(9).....	25.65
*CM-0171	7/8" groove	2 x 2 H.D. Cap.....	815.1640	(9).....	25.65
*CM-0171	7/8" groove	2 x 2 H.D. Divider	815.1645	(9).....	25.65

CEDAR SHIMS			
<i>code</i>	<i>pcs. per bdl.</i>	<i>bdls. per ctn.</i>	<i>bdl.</i>
			
MI-041-bdl.	16 pieces	30 bdls.	2.43
MI-0024-ctn	(sold in full cartons only)		

Effective April 3, 2017

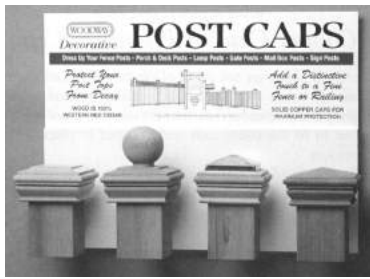













QUALITY CEDAR POST CAPS

Woodway Post Caps built to last. We use premium grade, kiln dried Western Red Cedar. Our blocks and trim skirts are precision-moulded for uniformity. Rabbeted joinery provides extra strength and durability- no marks or discoloration from rusty fasteners. Slip over post caps are sized to fit a range of nominal dimension lumber:

4" x 4"=3-5/8" 6" x 6"=5-5/8"

PRICED PER EACH - Deduct 10% for full cartons

*suggested
retail*

	<i>code</i>	<i>description</i>	<i>size</i>	<i>order #</i>	<i>ctn.</i>	<i>each</i>
	PC-717	Ball Finial - Georgian	4 x 4	870.1381	12	9.68
	PC-779	Flat Top	4 x 4	870.1382	12	13.19
	*PC-4201	Pyramid	4 x 4	870.1383	12	13.82
	PC-1271	Pyramid	6 x 6	870.1641	8	23.23
	*PC-9541	Glass-Black Opaque	4 x 4	870.3084	9	19.70
	*PC-9541	Glass-Cobalt Blue	4 x 4	870.3085	9	19.70
	*PC-9541	Glass-Olive Green	4 x 4	870.3086	9	19.70
	*PC-9541	Glass-Amber	4 x 4	870.3087	9	19.70
	*PC-8071	Copper Pyramid	4 x 4	870.1384	12	23.06
	*PC-2882	Copper Pyramid	6 x 6	870.1669	8	38.91
	*PC-5461	Small Copper Pyramid	4 x 4	870.1388	12	22.21
	*PC-9271	Copper Flat Top	4 x 4	870.1387	12	23.34
	PC-0641	Ball Top	4 x 4	870.1392	6	19.71
	*PC-8071	Mission Copper Pyramid	4 x 4	870.1824	12	23.06
	*PC-547	Cottage Flat Top	4 x 4	870.1391	12	10.06
	*PC-019	Copper Crown	4 x 4	870.1845	24	12.29
	*PC-581	Pyramid-Flat Bottom	4 x 4 (full ctn. only)	870.0002	24	2.50
	PC-063	Pyramid-Flat Bottom	6 x 6 (full ctn. only)	870.0003	12	4.86
	*PC-581	Standard-Flat Bottom	4 x 4 (full ctn. only)	870.0000	24	2.50
	PC-063	Standard-Flat Bottom	6 x 6 (full ctn. only)	870.0001	12	4.86

TIPS FOR MANAGERS AND SALESPeOPLE

HERE ARE SOME TIPS ON HOW YOU CAN BECOME A BETTER MANAGER OR SALESPERSON

1. Never answer the phone without a paper and pen ready (include date and contact).
2. Always write your commitments down on a *to do* list.
3. Always return phone calls ASAP. Even those names you do not recognize may bring you good news.
4. If you know it is bad news, call anyway so it doesn't hang over your head for the rest of the day.
5. Always return your customers phone calls immediately. They are the only reason you have a job.
6. When you have a large project, develop an action plan and a time table for each part of the plan..
7. Don't be afraid to ask others for help and advice. If you are so good that you do not need help, then you ought to find a better job.
8. You are no better than the people that work for you, so hire good workers and treat them with respect. Together you can be successful.

SALESPeOPLE:

Salespeople must set goals and prepare a clear-cut action plan to make sure that their plans come true. Goal setting is not the manger's job, it's the salesperson's job. The beauty of commissioned sales is that "your raise becomes effective when you do." Working hard is important, but working smart is even more important.

Effective April 3, 2017

SHIPPING INFORMATION

Estimated Shipping Weight Per 1000 Lineal Feet For Wood Mouldings - Hemlock, Pine, Alder, Mahogany, Poplar, and MDF.
Add 40% for Oak and Maple.

THICKNESS		1/4	9/32	5/16	3/8	7/16	1/2	9/16	5/8	11/16	3/4	1-1/8	1-3/8
WIDTH	1/4	9											
	5/16	12											
	3/8	14	16	17	21								
	1/2	19	21	23	28	33	37						
	5/8	23	26	29	35	41	47	53	59	59			
	3/4	28	32	35	42	49	56	63	70	70	84		
	7/8	33	37	41	49	57	66	74	82	82	98		
	1	37	42	47	56	66	75	83	94	94	112		
	1-1/8	42	47	53	63	74	84	95	105	105	126	190	
	1-1/4	47	53	59	70	82	94	106	117	117	140	211	
	1-3/8	52	58	64	77	90	103	116	129	129	154	232	283
	1-1/2	56	63	70	84	98	112	126	140	140	169	253	309
	1-5/8	61	68	76	91	104	122	137	152	152	183	274	335
	1-3/4	66	74	82	98	117	131	147	164	164	197	295	360
	2				112	131	150	169	187	187	225	337	412
	2-1/8				126	148	169	211	211	211	253	379	463
	2-1/4					164	187	222	234	234	281	421	515
	2-1/2					170	197	231	246	246	295	442	541
	2-5/8					180	206	252	257	257	309	463	566
	2-3/4							274	281	281	337	505	618
	3								304	304	365	548	669
	3-1/4								328	328	393	590	721
	3-1/2								339	339	407	611	750
	3-5/8								351	351	421	632	772
	3-3/4								374	374	477	716	875
	4-1/4								445	445	534	800	978
	4-3/4								515	515	618	927	1356
	5-1/2								538	538	646	969	1420
	5-3/4												

Conversion Table

Multiply lineal footage times conversion factor to find Board Foot Amount.

(example - 1x3: 1000 LIN FT x .25=250 BD FT)

1x2	.16667	5/4x2	.20833
1x3	.25	5/4x3	.3125
1x4	.33333	5/4x4	.41667
1x5	.41667	5/4x5	.52083
1x6	.5	5/4x6	.625
1x8	.66667	5/4x8	.83333
1x10	.83333	5/4x10	1.04167
1x12	1.0	5/4x12	1.25
2x2	.33333	3x3	.75
2x3	.5	3x4	1.0
2x4	.66667	3x6	1.5
2x5	.83333	3x8	2.0
2x6	1.0	3 x 10	2.5
2x8	1.3333	3x12	3.0
2x10	1.6667	4x4	1.3333
2x12	2.0	4x6	2.0
		4x8	2.6667
		4x10	3.3333
		4x12	4.0

Multiply per M Board Foot price times Factor to find Per M Lineal Foot price.

(ex. 1x3: Price 1200/M BD FT x .25 = 300/M LIN FT or .30/LIN FT)

Estimated Shipping Weight Per 100 Lineal Feet For Finish Lumber

	FIR	HEMLOCK POPLAR	MAHOGANY	OAK MAPLE	PINE ALDER	MDF
1x2	33	30	27	35	25	30
1x3	50	45	40	55	38	45
1x4	67	60	53	75	50	60
1x5	83	75	67	105	-	75
1x6	100	90	80	120	75	90
1x8	133	120	107	165	100	120
1x10	166	150	133	205	125	150
1x12	200	180	160	250	150	180
1-1/4x4	83	75	67	-	-	75
1-1/4x6	125	113	100	-	-	113
2x2	67	60	53	60		
2x3	100	90	80			
2x4	133	120	107	140		
2x6	200	180	160	230		
2x8	267	240	213	280		
2x10	333	300	266			
2 x 12	400	360	320			

Discounts and Specified Charges

Material and prices are subject to availability and change without notice.

Terms:

- 1% 10th Prox, Net 25th
- Finance Charges: 1-1/2% per month on past due balances
- Discounts Apply to Current Accounts Only

Discounts

- Lumber - Less 10% on 500 BD FT R/L one item
- Moulding Items - Less 10% on 5000 lin ft.

Specified Length Charge

- Lumber 5%
- 4' & 5' Lumber. sub 6' at no extra charge for footage

Returns:

- Returns need prior approval
- Returns are subject to a 10% restocking charge
- Special orders-no refunds
- Stock must be clean and in original condition

U.P.S. Charge:

\$5/package plus normal U.P.S.charges (or U.S. Mail)

Effective April 3, 2017

